



SIRCO M and MV

Universal load break switches
from 16 to 160 A

Load break
switches



4 pole SIRCO M
direct operation



4 pole SIRCO MV
direct operation

Function

SIRCO M and MV are manually operated and modular multipolar load break switches.

They make and break under load conditions and provide safety isolation for any low voltage circuit, particularly for machine control circuits.

Through the use of accessories, SIRCO M can be transformed into multipolar load break or 3/4 pole changeover switches. SIRCO M changeover switches provide on load changeover switching between two sources or two low voltage power circuits, as well as their safety isolation.

Advantages

Total integration

The SIRCO M and MV fully integrate isolation, breaking and switching functions.

Within a single product, SIRCO M offers front, right side or left side operation. Their highly functional design enables SIRCO M to be easily transformed from a load break switch to a changeover switch, offering a highly innovative modular solution for numerous applications.

Wide range of accessories

A single standard 3 pole load break switch module, which can be complemented with a choice of accessories, offers a range of advantages:

- Simplicity when choosing the device.
- Flexibility to adapt to the most varied applications.
- Reduction in the cost of management and storage.

Upgradeability

Its wide range of accessories means that the SIRCO M can be upgraded, even after it has been commissioned, enabling future requirements to be met.

Compliance with major certifications and approvals

The SIRCO M and MV range of load break switches have been designed, qualified and tested according to the criteria defined by standards IEC 60947-3, UL508 and UL98.

This process guarantees a high quality level for the product which is fully adapted to arduous operating environments.

General characteristics

- Double break per pole.
- Mounting options: DIN-rail, panel or modular panel with 45 mm front cut-out.
- IP20 accessories.
- Severe utilisation categories (AC-22 and AC-23).

Specific characteristics

SIRCO M:

- Positive break indication.
- Contact point technology.
- Product can be mounted directly on the door or panel side; see "Door mounting kit" in the accessory section.

SIRCO MV:

- Visible double breaking based.
- Positive break indication.

The solution for

- > Main incoming load break.
- > Distribution load break.
- > Machine control.
- > Local safety load break.



Strong points

- > Total integration.
- > Wide range of accessories.
- > Upgradeability.
- > Compliance to major certifications and approvals.
- > Specific characteristics.

Conformity to standards

- > IEC 60947-3



- > Other standards available:



*See pages SIRCO UL and CSA range

Approvals and certifications⁽¹⁾



(1) Product reference on request.

Local safety enclosures

- > Fitted within a polycarbonate enclosure, the SIRCO M can be used, for example, for on-load breaking of a motor (AC23).



What you need to know

SIRCO M

- SIRCO M can be operated in 3 different ways:



Complete switch body for toggle operation



Direct front operation with handle



External operation
 front, left side or right side

- The SIRCO M is a **3 pole** load break switch which is available from **16 to 125 A**. It can be combined with a switched 4th pole, an unswitched neutral or PE pole and pre-break and signalling auxiliary contacts.
- The basic 3 pole device is available enclosed in a polycarbonate enclosure from 16 to 100 A (see page 600).
- From **16 to 125 A**, through the wide range of available accessories, it is possible to convert a **3 pole SIRCO M into a 4, 6 or 8 pole load break switch** or a **3/4 pole changeover switch**.
- Through use of its door mounting kit, SIRCO M load break switches can be mounted on the panel door.



Changeover switches I - 0 - II

SIRCO MV

- 3 operations are available:

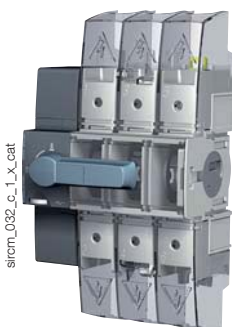

Direct front operation



External **right side** operation

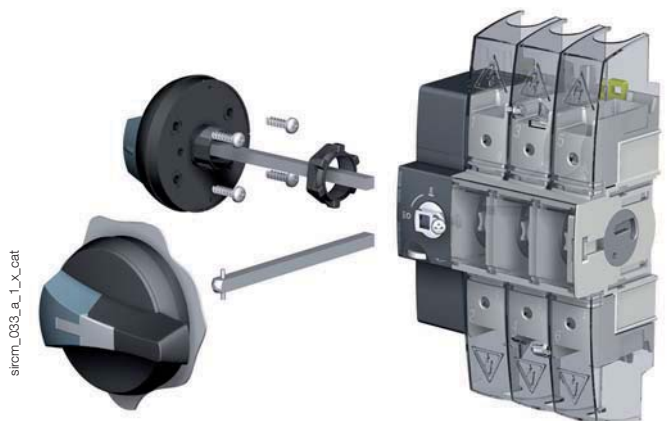

External **front and left side** operation

- SIRCO MV can be ordered in **3 or 4 pole** from **100 to 160 A**.
- Two types of auxiliary contacts are available:
 - U-type pre-break,
 - M-type for signalisation.

SIRCO M and MV

Universal load break switches

from 16 to 160 A

References

SIRCO M

Rating (A)	No. of poles	Complete switch body with toggle operation	Switch body	Direct handle	Door interlocked external front and right side handle ⁽⁵⁾	External left side handle ⁽⁵⁾	External front handle for changeover switch ⁽⁵⁾	Shaft for external front and side handle ⁽⁵⁾	4 th pole
16 A	3 P	2205 3000	2200 3000 ⁽¹⁾⁽²⁾⁽³⁾	M00 type Blue 2299 5012 Red 2299 5013	S00 type I-0 Black IP55 1471 1111 ⁽⁴⁾ Black IP65 1473 1111 ⁽⁴⁾ Red/Yellow IP65 1474 1111 ⁽⁴⁾	S00 type I-0 Black IP65 147A 5111 Red/Yellow IP65 147B 5111	S00 type I-0 - II Black IP65 1473 1113 ⁽⁴⁾ I - I+II - II Black IP65 1473 1114 ⁽⁴⁾	S0, S00 type 150 mm 1407 0515 200 mm 1407 0520 320 mm 1407 0532	2200 1000
20 A	3 P	2205 3001	2200 3001 ⁽¹⁾⁽²⁾⁽³⁾						2200 1001
25 A	3 P	2205 3002	2200 3002 ⁽¹⁾⁽²⁾⁽³⁾						2200 1002
32 A	3 P	2205 3003	2200 3003 ⁽¹⁾⁽²⁾⁽³⁾						2200 1003
40 A	3 P	2205 3004	2200 3004 ⁽¹⁾⁽²⁾⁽³⁾						2200 1004
63 A	3 P	2205 3006	2200 3006 ⁽¹⁾⁽²⁾⁽³⁾						2200 1006
80 A	3 P	2205 3008	2200 3008 ⁽¹⁾⁽²⁾⁽³⁾						2200 1008
100 A	3 P		2200 3010 ⁽¹⁾⁽²⁾⁽³⁾	M01 type Blue 2299 5032	S0 type I-0 Black IP55 1481 1111 ⁽⁴⁾ Black IP65 1483 1111 ⁽⁴⁾ Red/Yellow IP65 1484 1111 ⁽⁴⁾	S0 type I-0 Black IP65 148A 5111 Red/Yellow IP65 148B 5111		2200 1010	
125 A	3 P		2200 3011 ⁽¹⁾⁽²⁾⁽³⁾					2200 1011	

(1) Front and side operation.

(2) For a 6-pole device in direct operation, order 2 x 3 pole device + conversion kit (for external operation, add the shaft + the handle).

(3) For an 8-pole device in direct operation, order 2 x 3 pole device + 2 x 4th poles + conversion kit (for external operation, add the shaft + the handle).

(4) Defeatable handle.

(5) Other handles are available. Please see accessory pages.

SIRCO M

Rating (A)	No. of poles	Complete switch body toggle operation	Switch body	Unswitched neutral pole	Unswitched protective earth module	Auxiliary contact	Terminal shrouds	Door mounting kit
16 A	3 P	2205 3000	2200 3000 ⁽¹⁾⁽²⁾⁽³⁾				1 P 2294 1005 ⁽⁴⁾ 3 P 2294 3005 ⁽⁴⁾	3/4 P Complete protection IP2X 2299 3309 ⁽⁵⁾ Compact design 2209 3409 ⁽⁵⁾
20 A	3 P	2205 3001	2200 3001 ⁽¹⁾⁽²⁾⁽³⁾					
25 A	3 P	2205 3002	2200 3002 ⁽¹⁾⁽²⁾⁽³⁾					
32 A	3 P	2205 3003	2200 3003 ⁽¹⁾⁽²⁾⁽³⁾					
40 A	3 P	2205 3004	2200 3004 ⁽¹⁾⁽²⁾⁽³⁾					
63 A	3 P	2205 3006	2200 3006 ⁽¹⁾⁽²⁾⁽³⁾	1 P 2200 5005	1 P 2200 9005	M-type contact	1 P 2294 1009 ⁽⁴⁾ 3 P 2294 3009 ⁽⁴⁾	6/8 P Steel support 2299 3609 ⁽⁵⁾
80 A	3 P	2205 3008	2200 3008 ⁽¹⁾⁽²⁾⁽³⁾	1 P 2200 5009	1 P 2200 9009	NO + NC 2299 0001		
100 A	3 P		2200 3010 ⁽¹⁾⁽²⁾⁽³⁾	1 P 2200 5011	1 P 2200 9011	2 NO 2299 0011		
125 A	3 P		2200 3011 ⁽¹⁾⁽²⁾⁽³⁾				1 P 2294 1011 ⁽⁴⁾ 3 P 2294 3016 ⁽⁴⁾	3/4 P Steel support 2299 3609 ⁽⁵⁾

(1) Front and side operation.

(2) For a 6-pole device in direct operation, order 2 x 3 pole device + conversion kit (for external operation, add the shaft + the handle).

(3) For an 8-pole device in direct operation, order 2 x 3 pole device + 2 x 4th poles + conversion kit (for external operation, add the shaft + the handle).

(4) Top and bottom.

(5) Delivered with a shaft.

SIRCO M and MV

Universal load break switches
from 16 to 160 A

References (continued)

SIRCO MV

Rating (A)	No. of poles	Switch body	Direct handle	External front and right side handle ⁽⁴⁾	External left side handle ⁽⁴⁾	Shaft for external front and side handle ⁽⁴⁾	Auxiliary signal contact	Pre-break auxiliary contact	Terminal shrouds
100 A	3 P	2200 3110							
	4 P	2200 4110							
125 A	3 P	2200 3012	M0b type Blue 2299 5042 ⁽¹⁾	S0 type I-0 Black IP65 1491 0111 ⁽²⁾	S0 type I-0 Black IP65 149A 9111	S0 type 150 mm 1409 0615	M-type contact NO + NC 2299 0001	U type 1 contact NC 3999 0701	3 P 2294 3016 ⁽³⁾
	4 P	2200 4012							
160 A	3 P	2200 3016		Red/Yellow IP65 1494 0111 ⁽²⁾		320 mm 1409 0632			
	4 P	2200 4016							

(1) Standard.

(2) Defeatable handle.

(3) Top and bottom.

(4) Other handles are available. Please see accessory pages.

Accessories

Direct operation handle

SIRCO M			
Rating (A)	Handle colour	Handle	Reference
16 ... 80	Blue	M00 type	2299 5012 ⁽¹⁾
16 ... 80	Red	M00 type	2200 5013
100 ... 125	Blue	M01 type	2200 5032 ⁽¹⁾

(1) Standard.

SIRCO MV			
Rating (A)	Handle colour	Handle	Reference
100 ... 160	Blue	M0b type	2299 5042 ⁽¹⁾
100 ... 160	Blue	M0 type	2299 5022

(1) Standard.



SIRCO M - External operation handle

S000 type handle							
Rating (A)	Type	No. of poles	Operation	Handle colour	External IP	Defeatable handle	Reference
16 ... 80	Switch	3/4 P	Front and side operation	Black	IP65	no	1463 5111
16 ... 80	Switch	3/4 P	Front and side operation	Red/Yellow	IP65	no	1464 5111
16 ... 80	Changeover switches I - 0 - II	3/4 P	Front	Black	IP65	no	1463 5113
16 ... 80	Changeover switches I - I+II - II	3/4 P	Front	Black	IP65	no	1463 5114



S00 type handle							
Rating (A)	Type	No. of poles	Operation	Handle colour	External IP	Defeatable handle	Reference
16 ... 80	Switch	3/4 P ⁽¹⁾	Front and side operation	Black	IP55	yes	1471 1111
16 ... 80	Switch	3/4 P ⁽¹⁾	Front and side operation	Black	IP65	yes	1473 1111
16 ... 80	Switch	3/4 P ⁽¹⁾	Front and side operation	Red/Yellow	IP65	yes	1474 1111
16 ... 80	Switch	3/4 P	Left side	Black	IP65	no	147A 5111
16 ... 80	Switch	3/4 P	Left side	Red/Yellow	IP65	no	147B 5111
100 ... 125	Switch	6/8 P	Front	Black	IP55	yes	1471 0111
100 ... 125	Switch	6/8 P	Front	Black	IP65	yes	1473 0111
100 ... 125	Switch	6/8 P	Front	Red/Yellow	IP65	yes	1474 0111
16 ... 80	Changeover switches I - 0 - II	3/4 P	Front	Black	IP65	yes	1473 1113
16 ... 80	Changeover switches I - I+II - II	3/4 P	Front	Black	IP65	yes	1473 1114
100 ... 125	Changeover switches I - 0 - II	3/4 P	Front	Black	IP65	yes	1473 0113
100 ... 125	Changeover switches I - I+II - II	3/4 P	Front	Black	IP65	yes	1473 0114

(1) Can also be used with 6 and 8 poles with front operation.



S0 type handle							
Rating (A)	Type	No. of poles	Operation	Handle colour	External IP	Defeatable handle	Reference
100 ... 125	Switch	3/4 P	Front and side operation	Black	IP55	yes	1481 1111
100 ... 125	Switch	3/4 P	Front and side operation	Black	IP65	yes	1483 1111
100 ... 125	Switch	3/4 P	Front and side operation	Red/Yellow	IP65	yes	1484 1111
100 ... 125	Switch	3/4 P	Left side	Black	IP65	no	148A 5111
100 ... 125	Switch	3/4 P	Left side	Red/Yellow	IP65	no	148B 5111



S01 type handle							
Rating (A)	Type	No. of poles	Operation	Handle colour	External IP	Defeatable handle	Reference
16 ... 125	Switch	3/4 P ⁽²⁾	Front and side operation	Black	IP65	yes	1403 2111
16 ... 125	Switch	3/4 P ⁽²⁾	Front and side operation	Red/Yellow	IP65	yes	1404 2111
16 ... 125	Changeover switches I - 0 - II	3/4 P	Front	Black	IP65	yes	1403 2113
16 ... 125	Changeover switches I - 0 - II	3/4 P	Front	Black	IP65	yes	1403 2813 ⁽¹⁾
16 ... 125	Changeover switches I - I+II - II	3/4 P	Front	Black	IP65	yes	1403 2114
16 ... 125	Changeover switches I - I+II - II	3/4 P	Front	Black	IP65	yes	1403 2814 ⁽¹⁾

(1) Padlockable in 3 positions

(2) Can also be used with 6 and 8 pole devices from 16 to 40 A.



SIRCO M and MV

Universal load break switches

from 16 to 160 A

Accessories (continued)

SIRCO MV - External operation handle

S0 type handle							
Rating (A)	Type	No. of poles	Operation	Handle colour	External IP	Defeatable handle	Reference
100 ... 160	Switch	3/4 P	Front and side operation	Black	IP55	yes	1491 0111
100 ... 160	Switch	3/4 P	Front and side operation	Black	IP65	yes	1493 0111
100 ... 160	Switch	3/4 P	Front and side operation	Red/Yellow	IP65	yes	1494 0111
100 ... 160	Switch	3/4 P	Left side	Black	IP65	no	149A 9111
100 ... 160	Switch	3/4 P	Left side	Red/Yellow	IP65	no	149B 9111



S0 handle

access_343_a

S1 type handle							
Rating (A)	Type	No. of poles	Operation	Handle colour	External IP	Defeatable handle	Reference
100 ... 160	Switch	3/4 P	Front	Black	IP55	yes	1411 2111
100 ... 160	Switch	3/4 P	Front	Black	IP65	yes	1413 2111
100 ... 160	Switch	3/4 P	Front	Red/Yellow	IP65	yes	1414 2111
100 ... 160	Switch	3/4 P	Right side	Black	IP55	no	1415 2111
100 ... 160	Switch	3/4 P	Right side	Black	IP65	no	1517 2111
100 ... 160	Switch	3/4 P	Right side	Red/Yellow	IP65	no	1418 2111
100 ... 160	Switch	3/4 P	Left side	Black	IP65	no	141A 2111
100 ... 160	Switch	3/4 P	Left side	Red/Yellow	IP65	no	141B 2111



S1 Handle

access_284_a_2_cat

Shaft for external handle

SIRCO M 3/4 P				
Rating (A)	Handle	Type	Length (mm)	Reference
16 ... 125	S000/S00/S0 type	Switch	150 mm	1407 0515
16 ... 125	S000/S00/S0 type	Switch	200 mm	1407 0520
16 ... 125	S000/S00/S0 type	Switch	320 mm	1407 0532
16 ... 125	S01 type	Switch	200 mm	1404 0520
16 ... 125	S01 type	Switch	320 mm	1404 0532
16 ... 125	S01 type	Switch	400 mm	1404 0540



access_346_a_1_cat

SIRCO M 6/8 P load break switch and 3/4 P changeover switch				
Rating (A)	Handle	Type	Length (mm)	Reference
16 ... 80	S00, S000 type	6/8 P and changeover switch	150 mm	1407 0515
16 ... 80	S00, S000 type	6/8 P and changeover switch	200 mm	1407 0520
16 ... 80	S00, S000 type	6/8 P and changeover switch	320 mm	1407 0532
100 ... 125	S00 type	6/8 P and changeover switch	150 mm	1409 0615
100 ... 125	S00 type	6/8 P and changeover switch	200 mm	1409 0620
100 ... 125	S00 type	6/8 P and changeover switch	320 mm	1409 0632
16 ... 40	S01 type	6/8 P	200 mm	1404 0520
16 ... 40	S01 type	6/8 P	320 mm	1404 0532
16 ... 40	S01 type	6/8 P	400 mm	1404 0540
16 ... 80	S01 type	Changeover switch	200 mm	1404 0520
16 ... 80	S01 type	Changeover switch	320 mm	1404 0532
16 ... 80	S01 type	Changeover switch	400 mm	1404 0540
100 ... 125	S01 type	Changeover switch	150 mm	1409 0615
100 ... 125	S01 type	Changeover switch	200 mm	1409 0620
100 ... 125	S01 type	Changeover switch	320 mm	1409 0632

Use

Standard lengths:

- 150 mm,
- 200 mm,
- 320 mm,
- 400 mm.

Other lengths: Please consult us.

For 3/4 pole switches, shaft extensions are for external front and side operation.

For 6/8 pole switches and changeover switches, shaft extensions are for front operation only.

For SIRCO MV				
Rating (A)	Handle	Type	Length (mm)	Reference
100 ... 160	S0 type	Switch	150 mm	1409 0615
100 ... 160	S0 type	Switch	200 mm	1409 0620
100 ... 160	S0 type	Switch	320 mm	1409 0632
100 ... 160	S1 type	Switch	200 mm	1401 0620
100 ... 160	S1 type	Switch	320 mm	1401 0632
100 ... 160	S1 type	Switch	400 mm	1401 0640

Shaft guide for external operation

Use

To guide the shaft extension into the external handle.

This accessory enables handle to engage extension shaft with a misalignment of up to 15 mm.
Required for a shaft lengths over 320 mm.



access_260_a_2_cat

Description	Handle type	To be ordered in multiples of	Reference
Shaft guide	S00 and S0 / S000	10 pieces	1419 0000
Shaft guide	S01 and S1	1 piece	1429 0000

4th pole- Additional pole for SIRCO M

Use

Installation of this switched pole converts:

- a 3 pole SIRCO M into a 4 pole load break switch,
- a 6 pole SIRCO M into an 8 pole load break switch,
- a 3 pole SIRCO M changeover switch into a 4 pole changeover switch..

Rating (A)	No. of poles	Type	Reference
16	1 P	switched	2200 1000
20	1 P	switched	2200 1001
25	1 P	switched	2200 1002
32	1 P	switched	2200 1003
40	1 P	switched	2200 1004
63	1 P	switched	2200 1006
80	1 P	switched	2200 1008
100	1 P	switched	2200 1010
125	1 P	switched	2200 1011



4th pole

access_322_a



Protective earth module

access_323_a



Neutral pole

access_324_a

Neutral pole

Use

Provides a solid neutral pole for a 3 pole SIRCO M.

Rating (A)	No. of poles	Type	Reference
16 ... 40	1 P	unswitched	2200 5005
63 ... 80	1 P	unswitched	2200 5009
100 ... 125	1 P	unswitched	2200 5011

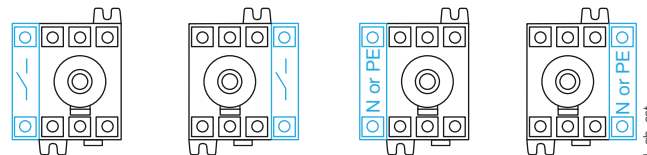

sirco_078_a_1_gb_cat

Protective earth module

Use

Provides a protective earth pole for a 3/4 pole SIRCO M.

Rating (A)	No. of poles	Type	Reference
16 ... 40	1 P	unswitched	2200 9005
63 ... 80	1 P	unswitched	2200 9009
100 ... 125	1 P	unswitched	2200 9011

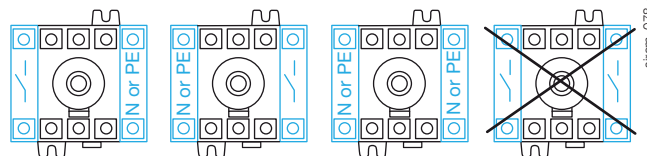

Additional pole configuration

Terminal shrouds

Use

Top and bottom protection against direct contact with the terminals or connection parts.

Available in 1 or 3 pole versions for SIRCO M and in 3 or 4 pole versions for SIRCO MV.

An opening on each terminal cover makes it possible to insert a temperature measurement probe.

For SIRCO M			
Rating (A)	No. of poles	Position	Reference
16 ... 40	1 P	top and bottom	2294 1005
16 ... 40	3 P	top and bottom	2294 3005
63 ... 80	1 P	top and bottom	2294 1009
63 ... 80	3 P	top and bottom	2294 3009
100 ... 125	1 P	top and bottom	2294 1011
100 ... 125	3 P	top and bottom	2294 3016

For SIRCO MV			
Rating (A)	No. of poles	Position	Reference
100 ... 160	3 P	top and bottom	2294 3016
100 ... 160	4 P	top and bottom	2294 4016



SIRCO M 3P



SIRCO M 1P

access_328_a

access_329_a



SIRCO MV 3P



SIRCO MV 4P

access_327_a

access_326_a

SIRCO M and MV

Universal load break switches

from 16 to 160 A

Accessories (continued)

M type auxiliary contacts

Use

Pre-break and signalisation of positions 0 and I by NO+NC or 2 NO auxiliary contacts. They allow to anticipate the switching of the main poles. They can be mounted on the left or on the right side of the device.

Max 4 auxiliary contacts (2 modules).

Pre-break is not guaranteed on the SIRCO MV.

Characteristics

NO+NC auxiliary contacts: IP2 with front operation.

M type

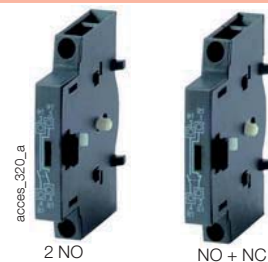

SIRCO M			
Rating (A)	Number of AC	Type of AC	Reference
16 ... 125	1 AC	NO + NC	2299 0001
16 ... 125	1 AC	2 NO	2299 0011
SIRCO MV			
Rating (A)	Number of AC	Type of AC	Reference
100 ... 160	1 AC	NO + NC	2299 0001
100 ... 160	1 AC	2 NO	2299 0011

Characteristics

Contact type	Nominal current (A)	Operating current I _o (A)	
		230 VAC	
		AC-13	AC-15
NO + NC	10	10	6

Auxiliary contact configurations for SIRCO MV

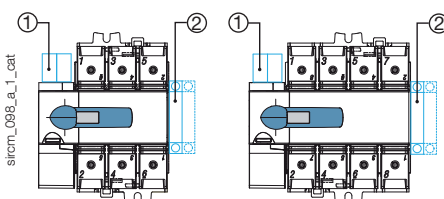

1. Maximum 2 "U" type auxiliary contacts.
2. Maximum 2 "M" type auxiliary contact modules.

Auxiliary contact configurations for SIRCO M

Max: 2 blocks / Max: 2 AC

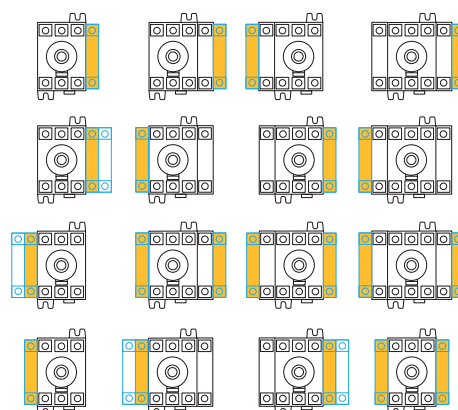

sircm_188_a_1_gb_cat

sircm_048_a_1_x_cat

For SIRCO MV

Rating (A)	Number of AC	Type of AC	Reference
100 ... 160	1 AC	NC	3999 0701
100 ... 160	1 AC	NO	3999 0702

Characteristics

Contact type	Nominal current (A)	Operating current I _o (A)			
		250 VAC	400 VAC	24 VDC	48 VDC
		AC-15	AC-15	DC-13	DC-13
NC	10	3	1.8	2.8	1.4
NO	10	3	1.8	2.8	1.4

U type



Use

Pre-break and signalisation by NO or NC auxiliary contact.

Maximum 2 auxiliary contacts. Only available for SIRCO MV switches.

Conversion kit

Use

This accessory enables the assembly of two 3 pole switches (+ additional pole) in order to create a:

- 6 or 8 pole SIRCO M load break switch,
- a 3 or 4 pole SIRCO M changeover switch.

SIRCO M changeover switches provide on load changeover switching between two sources or two low voltage power circuits, as well as their safety isolation (I - 0 - II); transfer without interruption of the supply is also possible (I - I+II - II).

Conversion kits are supplied with a direct front operation handle. For external operation the appropriate handle needs to be ordered.

Conversion kit for 6 or 8 pole load break switches



access_348_a

Conversion kit for changeover switches I - 0 - II



access_49_a



access_350_a

Conversion kit for changeover switches I - I+II - II

Load break switches 6/8 P		
Rating (A)	Type	Reference
16 ... 80	6/8P switch	2269 6009
100 ... 125	6/8P switch	2269 6011

Changeover switches I - 0 - II		
Rating (A)	Type	Reference
16 ... 80	Changeover switches I - 0 - II	2209 6009
100 ... 125	Changeover switches I - 0 - II	2209 6011

Changeover switches I - I+II - II		
Rating (A)	Type	Reference
16 ... 80	Changeover switches I - I+II - II	2299 6009
100 ... 125	Changeover switches I - I+II - II	2299 6011

Door mounting kit

Use

This kit enables the direct mounting of the switch on the panel door, or on the left or right side of the panel.
The connection clamps of the switch are always accessible.

The external handle is quick and easy to install with the supplied locking nut mounted on the inside of the enclosure.
3 kits are available:
- one for complete IP2X protection
- one with compact design
- one in steel for 6/8 P and 3/4 P 100/125 A.

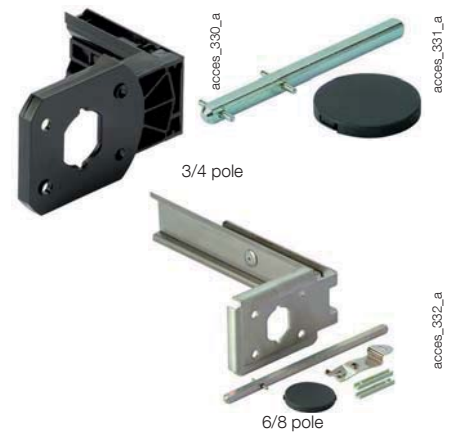

For SIRCO M

Rating (A)	No. of poles	Description	Reference
16 ... 80	3/4 P	Complete IP2X protection	2299 3309
16 ... 80	3/4 P	Compact version	2299 3409
16 ... 80	6/8 P	Steel support	2299 3609
100 ... 125	3/4 P	Steel support	2299 3609

Cap for side operation mounting

Use

This accessory enables the front face of the SIRCO M to be capped when the switch is side operated. 20 pieces supplied per pack.

This piece snaps into place directly on the front face of the switch.



For SIRCO M

Rating (A)	Pack	Reference
16 ... 125	20 pieces	2299 9409

6/8 pole joining accessory

Use

This accessory enables two 3/4 pole switches to be coupled in order to provide a 6 or 8 pole switch for external side operation. 40 pieces supplied per pack.

For multi-pole switches, please consult us.

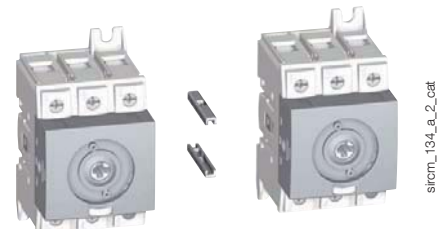

For SIRCO M

Rating (A)	Pack	Reference
16 ... 80	40 pieces	2299 9909

DIN rail locking clip

Use

This locking clip prevents the SIRCO MV from sliding when DIN rail mounted.

For SIRCO MV

Rating (A)	Type	Reference
100 ... 160	Locking clip M4	5000 0041
100 ... 160	Locking clip M5	5000 0051



Voltage sensing and power supply tap

Use

This single-pole voltage sensing tap allows the connection of 2 x ≤1,5 mm² voltage sensing or power cables to any SIRCO MV power terminal without reducing its connection capacity.

For SIRCO MV

Rating (A)	Pack	Reference
100 ... 160	2 pieces	1399 4006



Characteristics according to IEC 60947-3

SIRCO M - 16 to 125 A

Thermal current I_{th} (40 °C)	16 A	20 A	25 A	32 A	40 A	63 A	80 A	100 A	125 A
Rated insulation voltage U_i (V)	800	800	800	800	800	800	800	800	800
Rated impulse withstand voltage U_{imp} (kV)	8	8	8	8	8	8	8	8	8

Rated operational currents I_e (A)

Rated voltage	Utilisation category	A/B ⁽¹⁾	A/B ⁽¹⁾	A/B ⁽¹⁾	A/B ⁽¹⁾	A/B ⁽¹⁾	A/B ⁽¹⁾	A/B ⁽¹⁾	A/B ⁽¹⁾	A/B ⁽¹⁾
415 VAC	AC-20 A / AC-20 B	16/16	20/20	25/25	32/32	40/40	63/63	80/80	100/100	125/125
415 VAC	AC-21 A / AC-21 B	16/16	20/20	25/25	32/32	40/40	63/63	80/80	100/100	125/125
415 VAC	AC-22 A / AC-22 B	16/16	20/20	25/25	32/32	40/40	63/63	80/80	100/100	125/125
415 VAC	AC-23 A / AC-23 B	16/16	20/20	25/25	32/32	40/40	63/63	80/80	100/100	125/125
500 VAC	AC-20 A / AC-20 B	16/16	20/20	25/25	32/32	40/40	63/63	80/80	100/100	125/125
500 VAC	AC-21 A / AC-21 B	16/16	20/20	25/25	32/32	40/40	63/63	80/80	100/100	125/125
500 VAC	AC-22 A / AC-22 B	16/16	20/20	25/25	32/32	40/40	63/63	80/80	100/100	125/125
500 VAC	AC-23 A / AC-23 B	16/16	20/20	25/25	25/25	25/25	63/63	63/63	80/80	100/100
690 VAC	AC-20 A / AC-20 B	16/16	20/20	25/25	32/32	40/40	63/63	80/80	100/100	125/125
690 VAC	AC-21 A / AC-21 B	16/16	20/20	25/25	32/32	40/40	63/63	80/80	100/100	125/125
690 VAC	AC-22 A / AC-22 B	16/16	20/20	25/25	32/32	32/40	40/63	63/80	80/100	100/125
690 VAC	AC-23 A / AC-23 B	16/16	20/20	25/25	25/25	25/25	40/40	40/40	63/63	63/63

110 VDC	DC-20 A / DC-20 B	16/16	20/20	25/25	32/32	40/40	63/63	80/80	100/100	125/125
110 VDC	DC-21 A / DC-21 B	16/16 ⁽²⁾	20/20 ⁽²⁾	25/25 ⁽²⁾	32/32 ⁽²⁾	40/40 ⁽²⁾	63/63 ⁽²⁾	80/80 ⁽²⁾	100/100 ⁽²⁾	125/125 ⁽²⁾
250 VDC	DC-20 A / DC-20 B	16/16	20/20	25/25	32/32	40/40	63/63	80/80	100/100	125/125
250 VDC	DC-21 A / DC-21 B	16/16 ⁽³⁾	20/20 ⁽³⁾	25/25 ⁽³⁾	32/32 ⁽³⁾	40/40 ⁽³⁾	63/63 ⁽³⁾	80/80 ⁽³⁾	100/100 ⁽³⁾	125/125 ⁽³⁾
400 VDC	DC-20 A / DC-20 B	16/16	20/20	25/25	32/32	40/40	63/63	80/80	100/100	125/125
400 VDC	DC-21 A / DC-21 B	16/16 ⁽⁴⁾	20/20 ⁽⁴⁾	25/25 ⁽⁴⁾	25/25 ⁽⁴⁾	25/25 ⁽⁴⁾	40/40 ⁽⁴⁾	40/40 ⁽⁴⁾	63/63 ⁽⁴⁾	63/63 ⁽⁴⁾

Operational power in AC-23 (kW)

400 VAC without pre-break AC(kW) ⁽⁵⁾	7.5	9	11	15	18.5	30	37	45	55
500 VAC without pre-break AC(kW) ⁽⁵⁾	7.5	9	11	15	18.5	30	37	45	55
690 VAC without pre-break AC(kW) ⁽⁵⁾	7.5	11	15	15	15	30	37	45	55

Fuse protected short-circuit withstand (kA rms prospective)⁽⁶⁾

Prospective short-circuit current (kA rms)	50	50	50	50	50	50	50	25	25
Associated fuse rating (A)	16	20	25	32	40	63	80	100	125

Circuit breaker protected short-circuit withstand with any circuit breaker that ensures tripping in less than 0.3s

Rated short-time withstand current 0.3s. I_{cw} (kA rms)	2.5	2.5	2.5	2.5	2.5	3	3	5	5
--	-----	-----	-----	-----	-----	---	---	---	---

Short-circuit capacity (without protection)

Rated short-time withstand current 1s. I_{cw} (kA rms)	1.26	1.26	1.26	1.26	1.26	1.5	1.5	2.75	2.75
Rated short-circuit making capacity without fuses I_{cm} (kA peak)	1.8	1.8	1.8	1.8	1.8	2.1	2.1	3.9	3.9

Connection

Maximum Cu cable cross-section (mm ²)	1.5	1.5	1.5	1.5	1.5	2.5	2.5	10	10
Maximum Cu cable cross-section (mm ²)	16	16	16	16	16	35	35	70	70
Tightening torque min/max (Nm)	2 / 2.2	2 / 2.2	2 / 2.2	2 / 2.2	2 / 2.2	3.5 / 3.85	3.5 / 3.85	4/4.4	4/4.4

Mechanical characteristics

Durability (number of operating cycles)	100 000	100 000	100 000	100 000	100 000	100 000	100 000	100 000	100 000
Operating effort - 3 pole device (Nm)	1	1	1	1	1	1.4	1.4	1.6	1.6
Operating effort - 4 pole device (Nm)	1.2	1.2	1.2	1.2	1.2	1.6	1.6	2	2
Weight of a 3 pole device (kg)	0.18	0.18	0.18	0.18	0.18	0.27	0.27	0.55	0.55
Weight of a 4 pole device (kg)	0.23	0.23	0.23	0.23	0.23	0.33	0.33	0.72	0.72
Weight of a 6 pole device (kg)	0.40	0.40	0.40	0.40	0.40	0.59	0.59	1.30	1.30
Weight of a 8 pole device (kg)	0.50	0.50	0.50	0.50	0.50	0.69	0.69	1.65	1.65
Weight of a 3 pole device (kg)	0.40	0.40	0.40	0.40	0.40	0.59	0.59	1.30	1.30
Weight of a 4 pole device (kg)	0.50	0.50	0.50	0.50	0.50	0.69	0.69	1.65	1.65

(1) Category with index A = frequent operation - Category with index B = infrequent operation.

(2) one pole per polarity.

(3) 3-pole device with 2 poles in series for the "+" and 1 pole for the "-".

(4) 4-pole device with 2 poles in series per polarity.

(5) The power value is given for information only, the current values vary from one manufacturer to another.

(6) For a rated operational voltage $U_e = 415$ VAC

Characteristics according to IEC 60947-3

SIRCO MV - 100 to 160 A

Thermal current I_{th} (40 °C)	100 A	125 A	160 A	
Rated insulation voltage U_i (V)	800	800	800	
Rated impulse withstand voltage U_{imp} (kV)	8	8	8	
Rated operational currents I_e (A)				
Rated voltage	Utilisation category	A/B ⁽¹⁾	A/B ⁽¹⁾	A/B ⁽¹⁾
415 VAC	AC-20 A / AC-20 B	100/100	125/125	160/160
415 VAC	AC-21 A / AC-21 B	100/100	125/125	160/160
415 VAC	AC-22 A / AC-22 B	100/100	125/125	160/160
415 VAC	AC-23 A / AC-23 B	100/100	125/125	125/160
500 VAC	AC-20 A / AC-20 B	100/100	125/125	160/160
500 VAC	AC-21 A / AC-21 B	100/100	125/125	160/160
500 VAC	AC-22 A / AC-22 B	100/100	125/125	125/160
500 VAC	AC-23 A / AC-23 B	80/80	100/100	100/100
690 VAC	AC-20 A / AC-20 B	100/100	125/125	160/160
690 VAC	AC-21 A / AC-21 B	100/100	125/125	160/160
690 VAC	AC-22 A / AC-22 B	63/80	80/100	100/125
690 VAC	AC-23 A / AC-23 B	63/63	80/80	80/80
110 VDC	DC-20 A / DC-20 B	100/100	125/125	160/160
110 VDC	DC-21 A / DC-21 B	100/100 ⁽²⁾	125/125 ⁽²⁾	160/160 ⁽²⁾
250 VDC	DC-20 A / DC-20 B	100/100	125/125	160/160
250 VDC	DC-21 A / DC-21 B	100/100 ⁽³⁾	125/125 ⁽³⁾	160/160 ⁽³⁾
400 VDC	DC-20 A / DC-20 B	100/100	125/125	160/160
400 VDC	DC-21 A / DC-21 B	100/100 ⁽⁴⁾	125/125 ⁽⁴⁾	160/160 ⁽⁴⁾
Operational power in AC-23 (kW)				
400 VAC without pre-break AC(kW) ⁽⁵⁾	45	55	75	
500 VAC without pre-break AC(kW) ⁽⁵⁾	45	55	75	
690 VAC without pre-break AC(kW) ⁽⁵⁾	45	75	75	
Fuse protected short-circuit withstand (kA rms prospective)⁽⁶⁾				
Prospective short-circuit current (kA rms)	100	65	50	
Associated fuse rating (A)	100	125	160	
Circuit breaker protected short-circuit withstand with any circuit breaker that ensures tripping in less than 0.3s				
Rated short-time withstand current 0.3s. I_{cw} (kA rms)	7	7	7	
Short-circuit capacity (without protection)				
Rated short-time withstand current 1s. I_{cw} (kA rms)	4	4	4	
Rated short-circuit making capacity without fuses I_{cm} (kA peak)	7	7	7	
Connection				
Maximum Cu cable cross-section (mm ²)	10	10	10	
Maximum Cu cable cross-section (mm ²)	70	70	70	
Tightening torque min/max (Nm)	4 / 4.4	4 / 4.4	4 / 4.4	
Mechanical characteristics				
Durability (number of operating cycles)	50 000	50 000	50 000	
Operating effort - 3 pole device (Nm)	4	4	4	
Operating effort - 4 pole device (Nm)	4.2	4.2	4.2	
Weight of a 3 pole device (kg)	0.68	0.68	0.68	
Weight of a 4 pole device (kg)	0.85	0.85	0.85	

(1) Category with index A = frequent operation - Category with index B = infrequent operation.

(2) One pole per polarity.

(3) 2 poles in series for the "+" and 1 pole for the "-".

(4) 2 poles in series per polarity.

(5) The power value is given for information only, the current values vary from one manufacturer to another.

(6) For a rated operational voltage $U_s = 415$ VAC.

SIRCO M and MV

Universal load break switches

from 16 to 160 A

Dimensions

SIRCO M

SIRCO M 16 to 80 A

Toggle operation

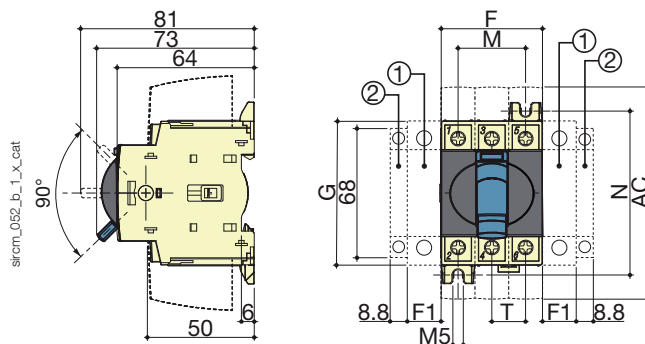

1. Location for: 1 switched fourth pole module (1 per device max.) or 1 unswitched neutral pole or 1 protective earth module or 1 auxiliary contact.
2. Position for 1 auxiliary contact module only.

Note: max 2 additional blocks.

Direct operation with handle

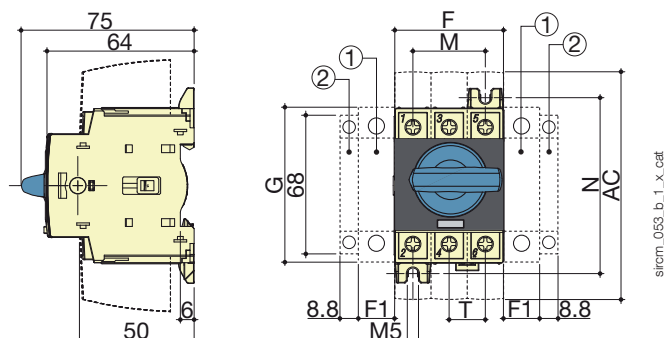

1. Location for: 1 switched fourth pole module (1 per device max.) or 1 unswitched neutral pole or 1 protective earth module or 1 auxiliary contact.
2. Position for 1 auxiliary contact module only.

Note: max 2 additional blocks.

External front operation

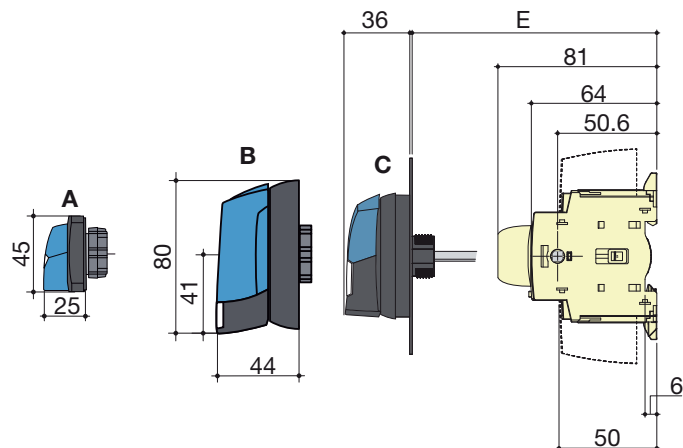

1. Location for: 1 switched fourth pole module (1 per device max.) or 1 unswitched neutral pole or 1 protective earth module or 1 auxiliary contact.
2. Position for 1 auxiliary contact module only.

Note: max 2 additional blocks.

External side operation

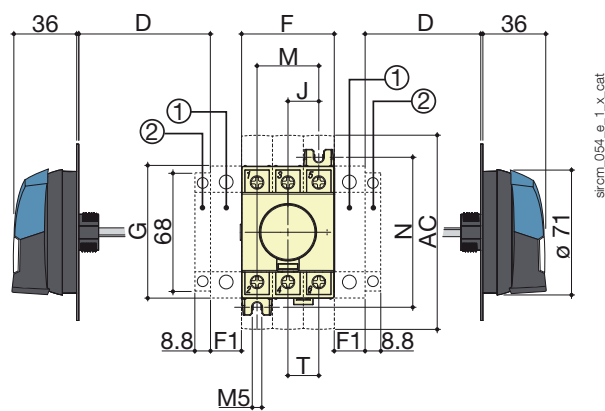

- A. S000 Handle
- B. S01 Handle.
- C. S00 Handle.

Rating (A)	Overall dimensions				Terminal shrouds	Switch body				Switch mounting		Connection
	D min	D max	E min	E max	AC	F	F1	G	J	M	N	T
16...40	30	235	100	372	110	45	15	68	15	30	75	15
63...80	30	235	100	372	110	52.5	17.5	76	17.5	35	85	17.5

SIRCO M

SIRCO M 16 to 80 A (continued)

Direct front operation for 6/8 pole load break switches or 3/4 pole changeover switches.

External front operation for 6/8 pole load break switches or 3/4 pole changeover switches.

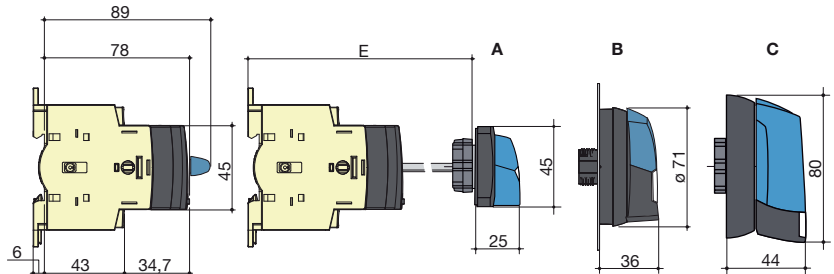
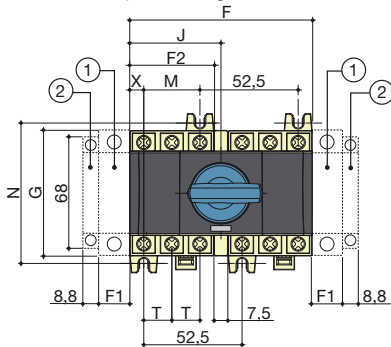

- 1. Location for: 1 switched fourth pole module (1 per device max.) or 1 unswitched neutral pole or 1 protective earth module or 1 auxiliary contact.

- 2. Position for 1 auxiliary contact module only.
- Note: max 2 additional blocks.**

- A. S000 Handle.
- B. S00 Handle.
- C. S01 Handle.

Rating (A)	Overall dimensions		Switch body					Switch mounting		Connection	
	E min	E max	F	F1	F2	G	J	M	N	T	X
16...40	105	372	97.5	15	45	68	48.75	30	75	15	7.5
63...80	105	372	105	17.5	52.5	76	52.5	35	85	17.5	8.75

SIRCO M 100 to 125 A

Direct operation with handle

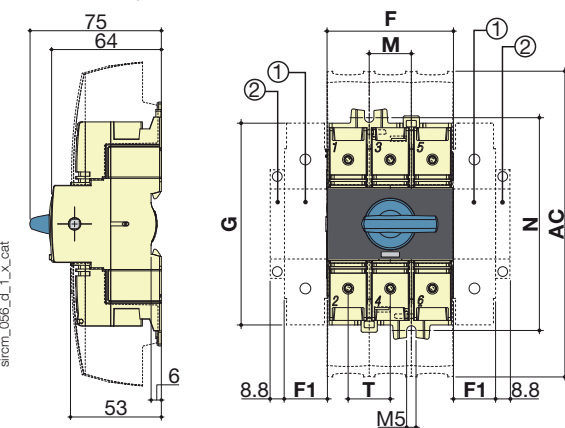

- 1. Location for: 1 switched fourth pole module (1 per device max.) or 1 unswitched neutral pole or 1 protective earth module or 1 auxiliary contact.
 - 2. Position for 1 auxiliary contact module only.
- Note: max 2 additional blocks.**

External front operation

External side operation

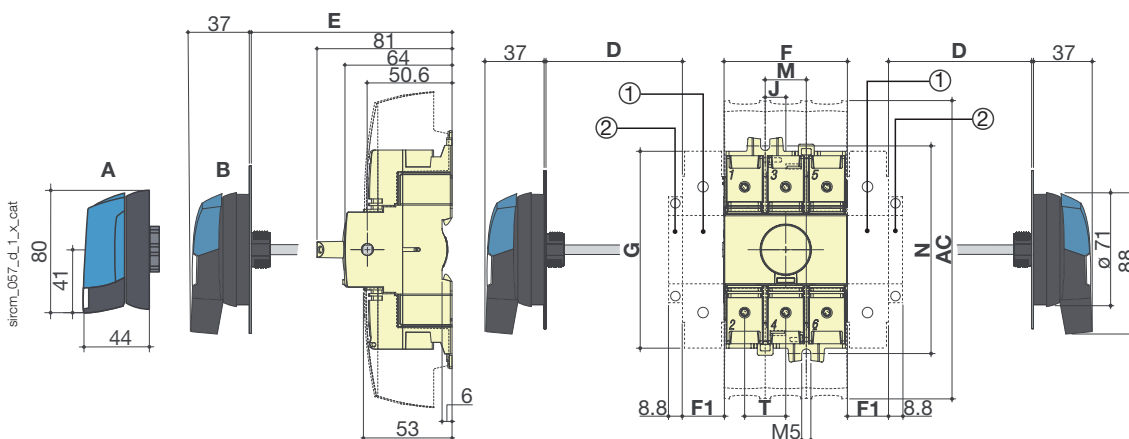

- 1. Location for: 1 switched fourth pole module (1 per device max.) or 1 unswitched neutral pole or 1 protective earth module or 1 auxiliary contact.

- 2. Position for 1 auxiliary contact module only.
- Note: max 2 additional blocks.**

- A. S01 Handle.
- B. S0 Handle.

Rating (A)	Overall dimensions				Terminal shrouds	Switch body				Switch mounting		Connection
	D min	D max	E min	E max	AC	F	F1	G	J	M	N	T
100 ... 125	30	201	100	372	189	78	26	124.6	13	26	131.4	26

SIRCO M and MV

Universal load break switches

from 16 to 160 A

Dimensions (continued)

SIRCO M 100 to 125 A 6/8 P and 3/4 P changeover switch

Direct front operation for 3/4 pole changeover switches

External front operation for 3 and 4 pole changeover switches

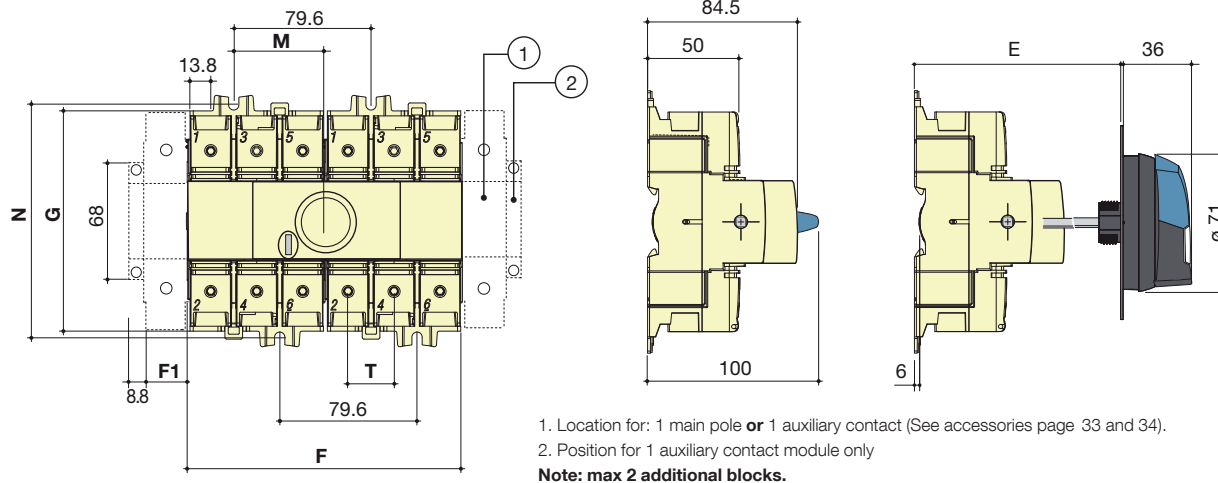

sirco_m_183_e_1_x_cat

Rating (A)	Overall dimensions		Switch body			Switch mounting		Connection
	E min	E max	F	F1	G	M	N	
100 ... 125	105	372	159	26	124.5	52.8	131.5	26

SIRCO MV

SIRCO MV - 100 to 160 A

Direct front operation

External front operation

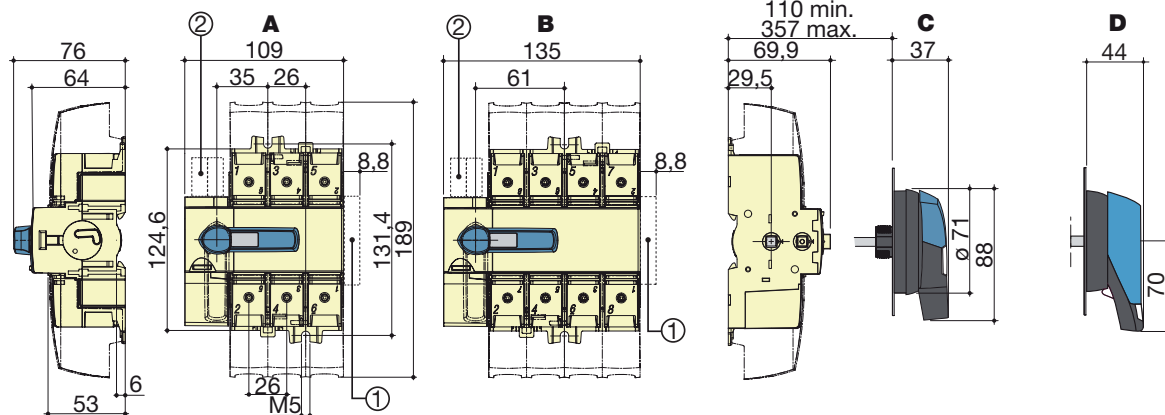

A. 3 poles
B. 4 poles

C. S0 type handle
D. S1 type handle

1. Maximum 4 "M" type auxiliary contacts
2. Maximum 2 "U" type auxiliary contacts

sirco_mv_058_c_1_x_cat

External side operation

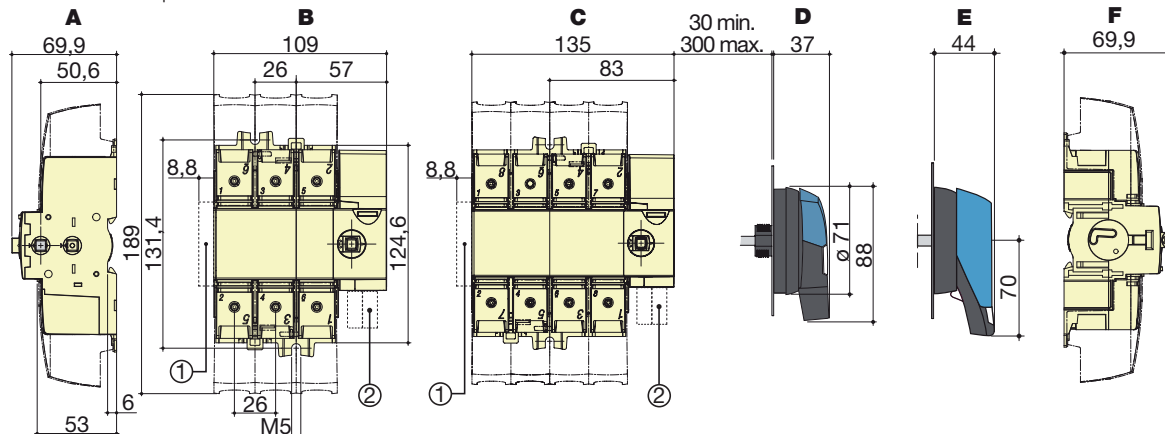

A. Right side operation.
B. 3 poles
C. 4 poles

D. S0 type handle
E. S1 type handle
F. Left side operation

1. Maximum 4 "M" type auxiliary contacts
2. Maximum 2 "U" type auxiliary contacts

sirco_mv_058_d_1_x_cat

Dimensions for external handles

SIRCO M

16 to 80 A				
Handle type	Front operation Direction of operation	Side operation Direction of operation	Door drilling	
S000 type Load break switches		Right side operation 	With 4 fixing screws 	With fixing nut
Handle type	Front operation Direction of operation		Door drilling	
S000 type Changeover switches I-0-II and I - I+II - II	0 or I+II 		With 4 fixing screws 	With fixing nut
Handle type	Front operation Direction of operation	Side operation Direction of operation	Door drilling	
S00 type Load break switches		Right side operation 	IP55 with 2 fixing clips 	IP65 with 4 fixing screws
		Left side operation 		With fixing nut
Handle type	Front operation Direction of operation		Door drilling	
S00 type Changeover switches I-0-II and I - I+II - II	0 or I+II 	IP55 with 2 fixing clips 	IP65 with 4 fixing screws 	With fixing nut

poign_016_a_1_gb_cat

poign_017_b_1_gb_cat

poign_024_a_1_gb_cat

poign_025_b_1_gb_cat

SIRCO M and MV

Universal load break switches

from 16 to 160 A

Dimensions for external handles

SIRCO M (continued)

16 to 80 A 3/4 P and 16 to 40 A 6/8 P

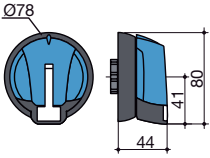
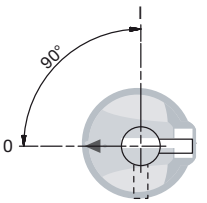
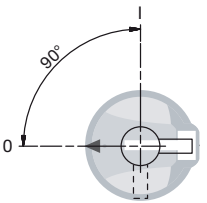
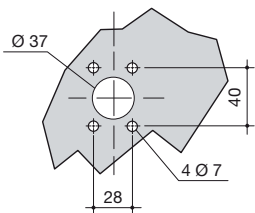
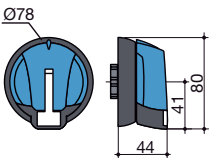
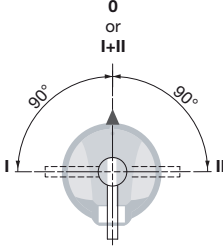
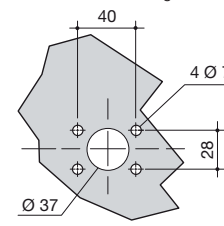
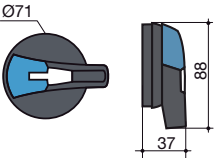
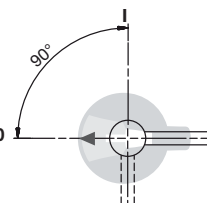
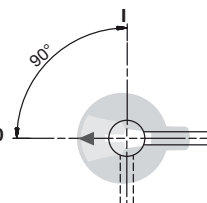
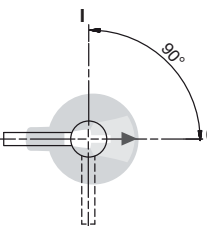
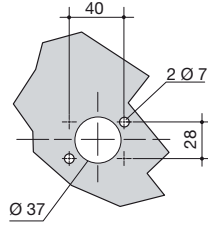
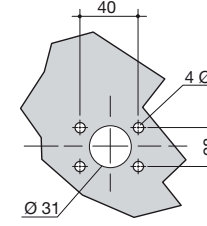
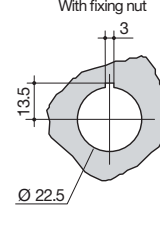
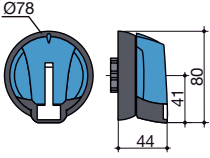
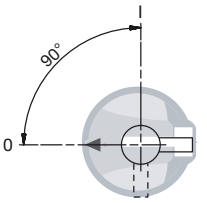
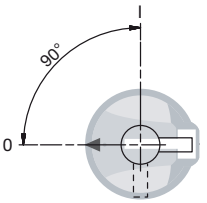
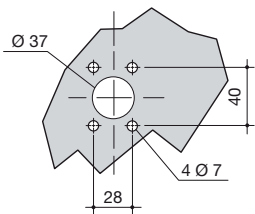
<p>Handle type</p> <p>S01 type Load break switches</p> 	<p>Front operation Direction of operation</p> 	<p>Side operation Direction of operation</p> <p>Right side operation</p> 	<p>Door drilling</p> <p>IP65 with 4 fixing screws</p> 
<p>Handle type</p> <p>S01 type Changeover switches I-0-II and I - I+II - II</p> 	<p>Front operation Direction of operation</p> <p>0 or I+II</p> 		<p>Door drilling</p> <p>IP65 with 4 fixing screws</p> 
<p>100 to 125 A</p>			
<p>Handle type</p> <p>S0 type Load break switches</p> 	<p>Front operation Direction of operation</p> 	<p>Side operation Direction of operation</p> <p>Right side operation</p>  <p>Left side operation</p> 	<p>Door drilling</p> <p>IP55 with 2 fixing clips</p>  <p>IP65 with 4 fixing screws</p>  <p>With fixing nut</p> 
<p>Handle type</p> <p>S01 type Load break switches</p> 	<p>Front operation Direction of operation</p> 	<p>Side operation Direction of operation</p> <p>Right side operation</p> 	<p>Door drilling</p> <p>IP65 with 4 fixing screws</p> 

poign_018_a_1_gb_cat

poign_019_b_1_gb_cat

poign_026_a_1_gb_cat

poign_018_a_1_gb_cat

SIRCO MV

100 to 160 A

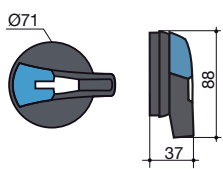
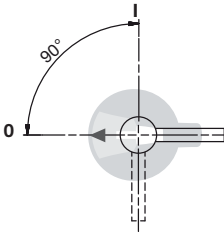
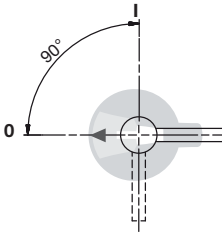
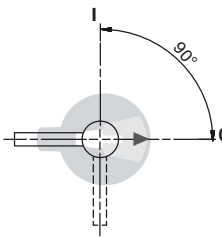
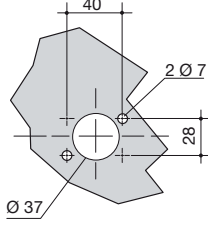
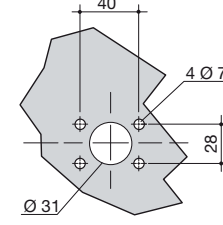
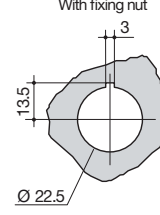
Handle type	Front operation Direction of operation	Side operation Direction of operation	Door drilling	
S0 type Load break switches 		Right side operation  Left side operation 	IP55 with 2 fixing clips  IP65 with 4 fixing screws  With fixing nut 	

poign_026_a_1_gb_cat

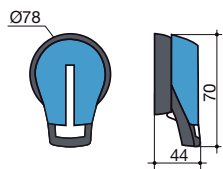
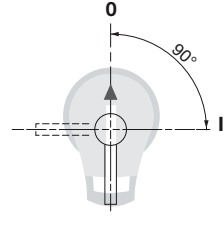
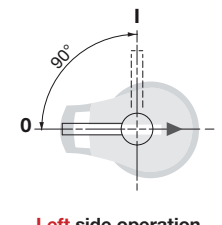
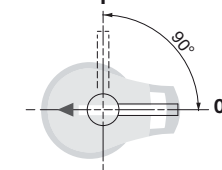
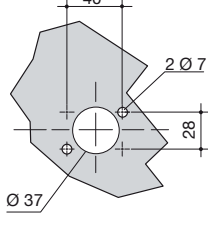
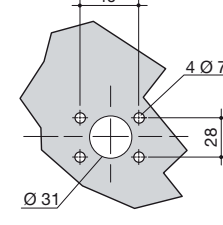
Handle type	Front operation Direction of operation	Side operation Direction of operation	Door drilling	
S1 type Load break switches 		Right side operation  Left side operation 	IP55 with 2 fixing clips  IP65 with 4 fixing screws 	

poign_027_a_1_gb_cat